



**ESTIC**

With us, the Future

**ESTIC CORPORATION**

URL <http://www.estic.co.jp>



**Head Office, Osaka Office & International Department**  
 2-5-9 Hashibahigashino-cho, Moriguchi-shi,  
 Osaka, 570-0031 Japan  
 Phone: +81-6-6993-8835 Fax: +81-6-6993-8881  
 Email: int\_dep@estic.co.jp

**Tokyo Office**  
 2F Shinyokohama Bousei Bldg., 3-20-12 Shin-Yokohama,  
 Kouhoku-ku, Yokohama-shi, Kanagawa, 222-0033 Japan  
 Phone: +81-45-474-3036 Fax: +81-45-474-3037  
 Email: tokyo\_office@estic.co.jp

**Chubu Office**  
 Yamahichi Higashiokazaki Bldg. 2F, 19-13, Kawabata,  
 Myodaiji-cho, Okazaki-city, Aichi, 444-0864 Japan  
 Phone: +81-564-66-0510 Fax: +81-564-66-0515  
 Email: chubu\_office@estic.co.jp

**Togo Office**  
 1-2-16 Togodori, Moriguchi-shi, Osaka, 570-0041 Japan  
 Phone: +81-6-6993-8077 Fax: +81-6-6993-8887

**SUBSIDIARIES**

**SHANGHAI ESTIC CO., LTD.**  
 No. 6, 51 Gate, 1159 Lane, Kangqiao East Road,  
 Pudong, Shanghai, 201315 China  
 Phone: +86-21-6813-0333 Fax: +86-21-6813-0777  
 Email: ecc@estic.cn

**ESTIC (THAILAND) CO., LTD.**  
 19 Naradhiwas Rajanakarin Road, Chong Nonsi,  
 Yannawa, Bangkok, 10120, Thailand  
 Phone: +66-2-678-0171 Fax: +66-2-678-0173  
 Email: sales@estic.co.th

**ESTIC AMERICA, INC.**  
 1895 Airport Exchange Blvd., Suite 220, Erlanger,  
 Kentucky, 41018 U.S.A.  
 Phone: +1-859-746-8800 Fax: +1-859-746-8777  
 Email: support@estic-america.com

**ESTIC**

With us, the Future

EH2-HT40

TRANSDUCERIZED ELECTRIC HANDHELD NUTRUNNER

# Handy 2000 Lite



●The colors of the products may slightly differ from those of the actual products, which is inevitable in printing.  
 ●The specifications and designs of the products may be changed without previous notice.

The contents of this brochure are as of May 2017

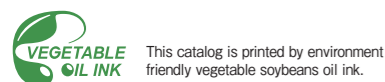

● Recycle paper is used for the catalog for environmental conservation.

17.5.30.MD

Advanced Technologies Combined  
to fasten Critical Areas  
throughout Worldwide Production















TRANSDUCERIZED ELECTRIC HANDHELD NUTRUNNER

# Handy 2000 Lite

The next generation handheld nutrunner "Handy 2000 Lite" is designed based on the concepts of quality, environment, ergonomics and versatility.

Estic has supplied the most advanced nutrunner systems to automotive, aviation and other industries and received high evaluations. The electric handheld nutrunner "Handy 2000 Lite" is produced by Estic using the finest electronic control, machinery and program technology available. The "Handy 2000 Lite" nutrunner is created based on the concepts of high-quality, environmental friendliness, variety system and ergonomic design. It incorporates pulse technology to reduce the reaction during fastening as well as the working load to the operator. The nutrunner is designed to preserve the environment by RoHS compliance and energy saving through electrical operation. Its stable controlling performance achieves the same high quality and accurate fastening as that of larger fixture type nutrunner systems. The innovative handheld nutrunner available only from Estic continues to support production in the future.

## INDEX

QUALITY.....	3	
ENVIRONMENT.....	4	
ERGONOMICS.....	5 ~ 6	
ANGLE TOOL & STRAIGHT TOOL.....	7 ~ 8	
PISTOL TOOL.....	9 ~ 10	
LOW TORQUE ADAPTATION TOOL.....	11 ~ 12	
TOOL(FUNCTIONS).....	13 ~ 14	
CONTROLLER.....	15 ~ 20	
A COST REDUCTION EXAMPLE WITH THE NEW FUNCTIONS.....	21 ~ 22	
HANDY 2000 MANAGEMENT SOFTWARE.....	23 ~ 24	
TOOLS.....	25 ~ 27	
CONTROLLERS.....	28	
TRACER ARM.....	29 ~ 30	
CABLES.....	31	
ACCESSORIES.....	32 ~ 34	



# 【ISO 5393】

The high level fastening quality required for critical areas is achieved with the advanced measuring capability and controlling performance of the Handy 2000 Lite manufactured based on ISO9001 to offer the highest quality



## Traceability

The fastening performance of the nutrunner is evaluated with inspection equipment (indicator) that complies with the international standard ISO5393 and the inspection report is issued with each tool.

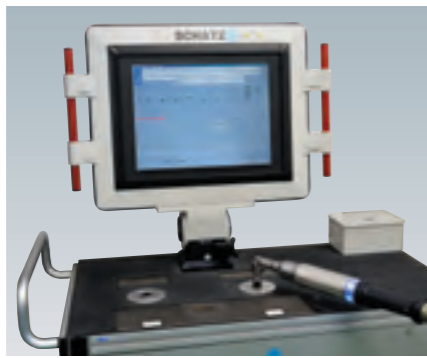

Certificate of indicator



Performance inspection report

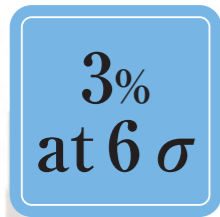

## Excellent fastening accuracy

The fastening performance of 3% at 6σ (3σ/x = ± 3%) is guaranteed by the inspection equipment according to ISO5393.



## High level quality control

Handy 2000 Lite is manufactured according to ISO9001 and supplied and serviced with the international standard level.



## High speed sampling and response

The torque and angle readings are monitored every 1/2000 second to control the target values.

# 【Energy saving】 【RoHS compliance】

Earth and Environmentally-friendly products. Estic's electric handheld nutrunners support future production in harmony with the environment.



## Energy saving tool

Improvement in energy efficiency is a must to reduce CO<sub>2</sub> emissions which promote global warming. The electric handheld nutrunner "Handy 2000 Lite" consumes about 1/20 the energy in comparison with compressed air powered pneumatic nutrunners. It is an energy saving tool that allows operation while reducing negative impacts to the environment.



## Clean and quiet working environment

Handy 2000 Lite does not generate such oil mist or noise as generated by pneumatic nutrunners, and thus constantly provides clean and quiet working environment.



## RoHS compliance

Handy 2000 Lite conforms to RoHS directive of EU (European Union) stipulating abolition and alternatives of the hazardous materials such as lead with the consideration to environmental friendliness.

### 【What is RoHS Directive?】

RoHS is the acronym for Restriction of the use of certain Hazardous Substances in electrical and electronic equipment, and the restriction is applied by European Union (EU) to 6 substances of lead, mercury, cadmium, hexavalent chrome, PBB (polybrominated biphenyl), and PBDE (Polybrominated diphenyl ether) in electric and electronic equipment marketed in EU.

## TRANSDUCERIZED ELECTRIC HANDHELD NUTRUNNER

# [Pulse fastening]

Reaction during fastening has been significantly reduced while maintaining the high torque accuracy available only with electric tool

Estic's patented pulse technology reduces the reaction generated during fastening with an electric handheld tool. The required torque values are read at 1/2000 of a second to control the subsequent fastening force (electric current). The Handy 2000 Lite allows highly accurate and safe fastening without the need of a reaction device.

Letter of patent (Japan)



Letter of patent (U.S.A.)



Letter of patent (China)



Pulse fastening  
Reaction : small

Conventional electric handheld tool  
Reaction : large

Torque change according to the current command

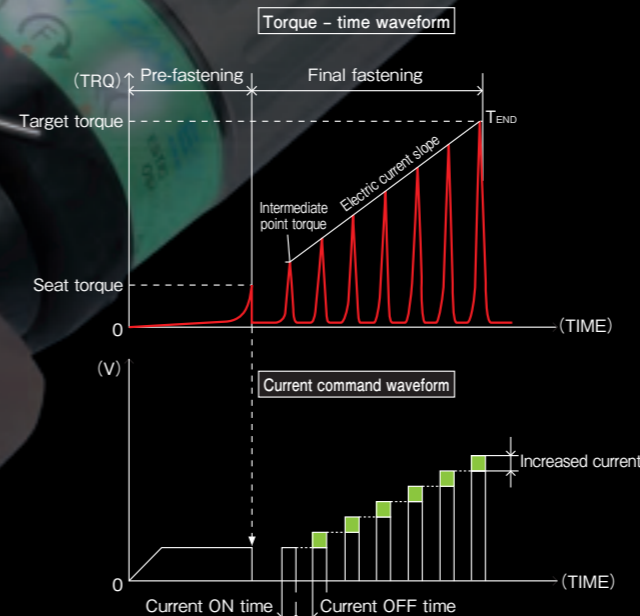

Command flow chart

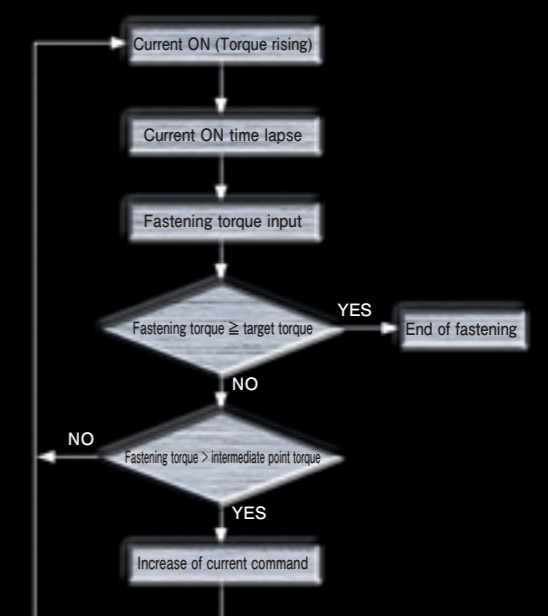

ERGONOMICS  
ELECTRIC HANDHELD NUTRUNNER

ERGONOMICS  
ELECTRIC HANDHELD NUTRUNNER

# ANGLE TOOL & STRAIGHT TOOL

## ANGLE TOOL

### Titanium alloy angle head

The angle head made of titanium featuring light weight materials and high tensile strength reduces the operator's load during fastening and provides high durability.

### Standard option



Ball plunger



Long switch lever (EH2-LS02)



Short switch lever (EH2-LS01)

EH2-R1020-A  
※Full scale

### Lightweight and high speed motor

The lightweight motor is used to reduce the burden to the operator from the tool weight during operation. The high speed motor is used to improve the productivity.

## STRAIGHT TOOL

### Involute spline

Allows various applications including multiple spindle configuration and mounting on an assisting arm. The flanged spindle is provided with the high torque model.

### Customization examples

Multi-spindles

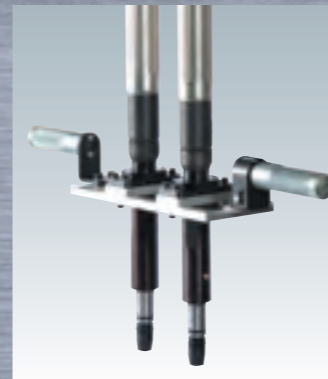

Assisting arm



Crow foot gear



Flush socket



EH2-R1016-S  
※Full scale

Contact us about the details for the customized products.

# PISTOL TOOL

## Optional involute spline

Allows various applications including multiple spindle configuration and mounting on an assisting arm.



## Rail guide

A rail guide is used for various applications such as hanging fixture to mount easily and securely.

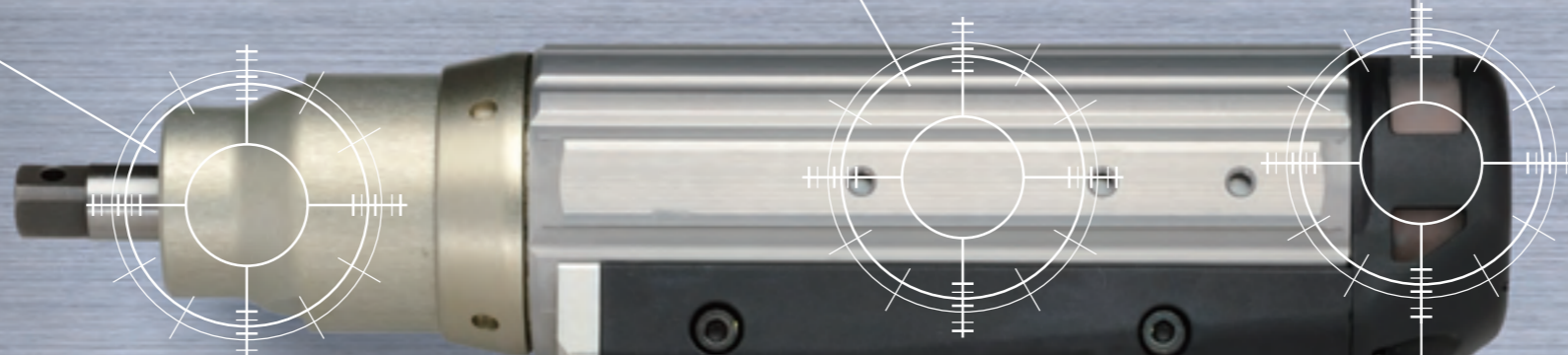

## The tool with the hanging fixture (EH2-PH02) mounted



# PISTOL TOOL

## Compact tool with high speed exceeding 3000rpm

Though compact and lightweight, the high maximum speed of 3075 rpm (EH2-H0015-P, EH2-H1030-P) is achieved for ease of use and high productivity.

## 50Nm electric pulse model (EH2-P1050-P)



## Indicator window

An omnidirectional confirmation window with excellent visibility is used to make the operating condition visible at any time.

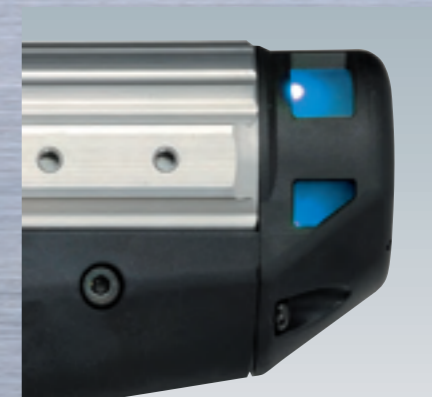

EH2-R1016-P  
※Full scale

## Ergonomically suited grip

The pistol type grip is used for operators to easily grip and prevent fatigue during long period operation.

# LOW TORQUE ADAPTATION TOOL

## Lever Start Type



Push the lever to activate the tool, and release it to stop.

## Push-to-Start Type



Push the bit onto the screw to activate the tool, and release it to stop.

Critical security parts require traceability, whether the torque is small or large. This tool helps you to achieve better quality with automobile industry products, including sensors, cables, and airbags, as well as products for the aircraft and home electronics industries.

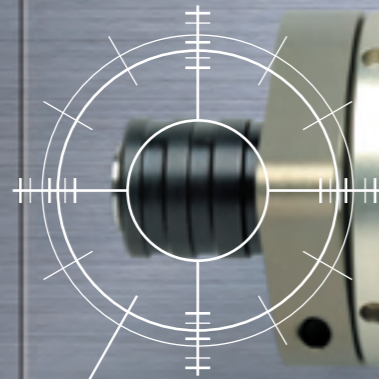

## Bit Holder

Slide-and-latch – Easily fit and remove the bit holder.  
Two options to activate the tool – Lever start and push-to-start.

## Pistol tool (EH2-R0005-P)



## Removable Flange

Remove the flange when using a single spindle. Utilize this feature together with the rail guide for use in various applications.

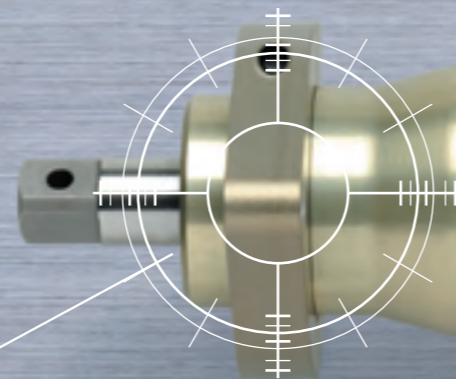

## Rail Guide

Rail guide employed for a multiple-spindle unit configuration and assist arms. Same horizontal type hanging hook can be used as pistol models.

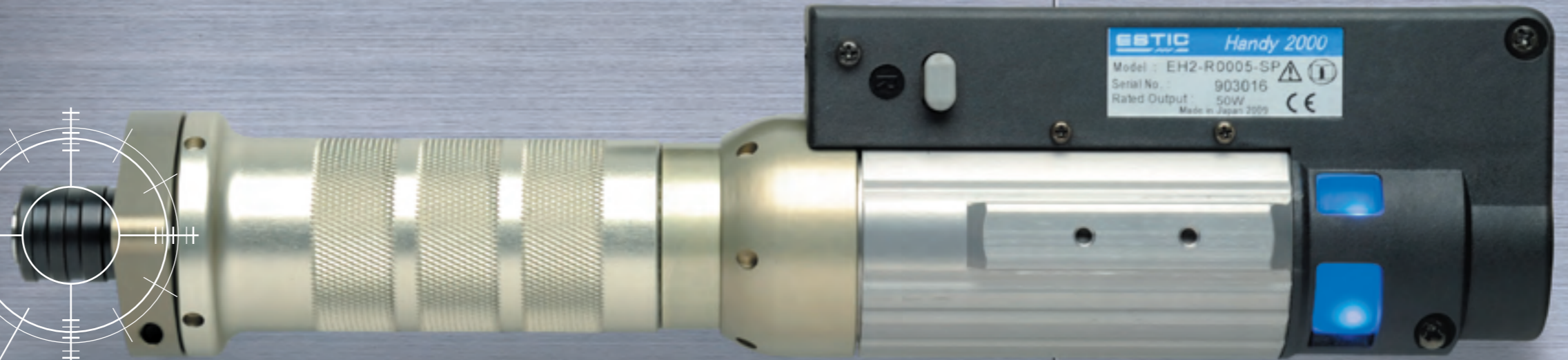
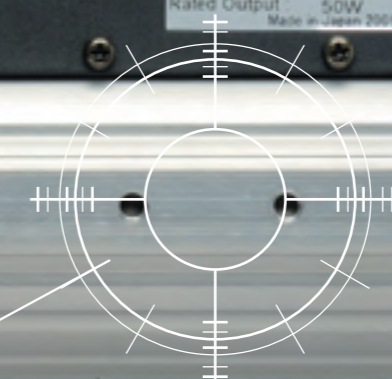

EH2-R0005-SP (Push-to-start type)  
※Full scale

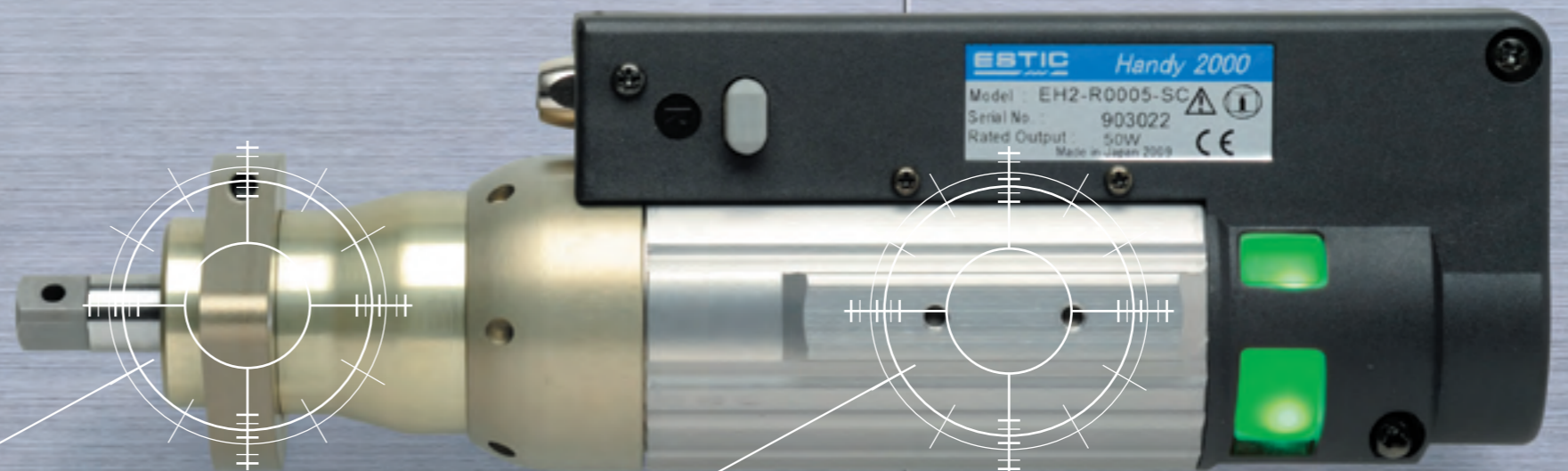

EH2-R0005-SC (Connector start type)  
※Full scale

# TOOL(FUNCTIONS)

ANGLE TOOL, STRAIGHT TOOL & PISTOL TOOL

Advanced functions support usability, accuracy and durability during fastening

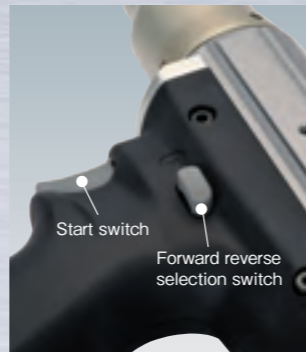

## High-intensity LED lamps

To inform the operator of the operating conditions in 7 colors with the LED lamps such as for OK/NG of fastening results (OK: green & NG: red or yellow) and fastening direction (forward rotation: blue & reverse rotation: purple), etc. The lamps are visible at any angle regardless of the posture of the operator.

## Start and forward reverse selection switch

The start trigger utilizes an IC contactless switch to offer high operability and reliability. The forward reverse selection switch provides reset function in addition to change the rotating direction. The push turn system that can be operated by a single hand is incorporated for the pistol tool.

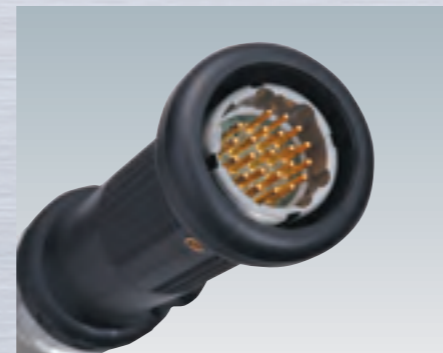

## Protection handle

The shock resistant handle is mounted to the aluminum alloy frame to minimize the impact if accidentally dropped. The ergonomically designed grip allows easy operation and reduces operator burden during extended use.

## Inner shell connector

The connector to connect the tool and the cable is installed in the frame inside the handle. It provides excellent durability against drop or impact.



## Angle/rotation speed sensor

The environmentally friendly high resolution resolver detects the angle used to control the servo-motor feed-back process. The resolution of 2048 or greater per rotation assures highly accurate speed control and fastening rotational angle.

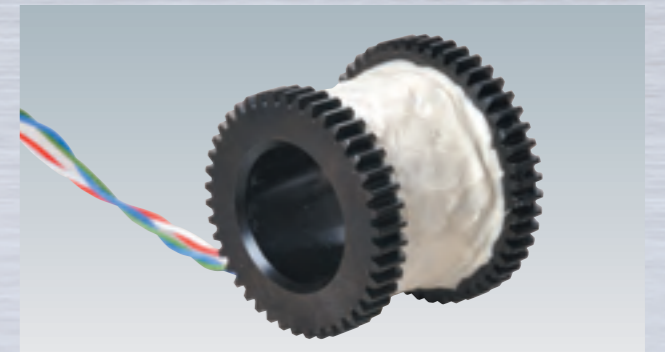

## Torque sensor

The strain gauge type torque transducer is built in to detect the torque. Gauges at 8 points and external disturbance self-cancellation function make the high accuracy torque detection possible.

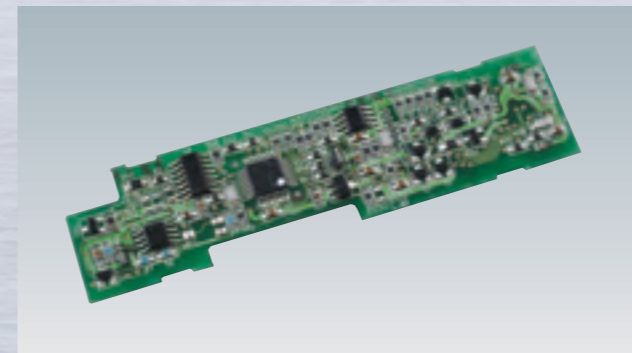

## Intelligent ID

The controller can be quickly setup when a tool is connected. An ID memory chip storing torque calibration value, gear ratio, and tool model is embedded into the tool. The records for frequency of repair and fastening counts are helpful for maintenance control.

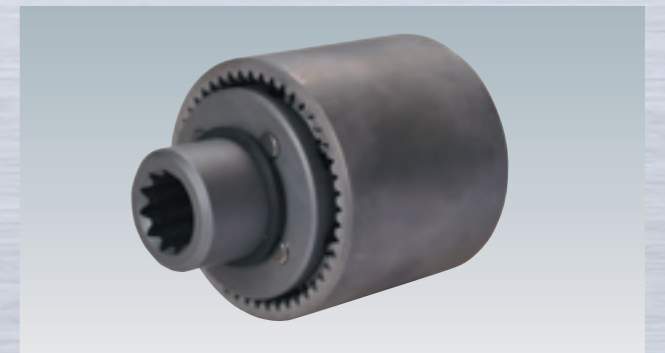

## Reduction gear

The compact design of the high power planetary gear assures excellent durability.



# CONTROLLER(SPECIFICATIONS)

Various field needs including visibility, operability, expandability and space saving are provided



## Large LED featuring high visibility

Large size 7 segmented LEDs are used for the display panel. OK and NG are indicated in an understandable way with green and red respectively.



OK indication



NG indication

## USB Flash drive

- Export Tightening result file
- Export/Import program file

## Centralized wiring on the bottom face

I/O terminals are concentrated on the bottom face to help package the wiring and save space.

### Connector for the tool cable

The system is automatically recognized when the tool is connected.

### Connector for the AC power supply

Connector for AC100V and AC200V power supply cables.

### Network connector

Used to control the multi-spindle, and Socket tray.

### Earth leakage breaker for the main power supply

The earth leakage breaker conforming to various international standards.

### RELAY/EXT IN

Relay (Output 2)  
Non voltage contact (Input 4)

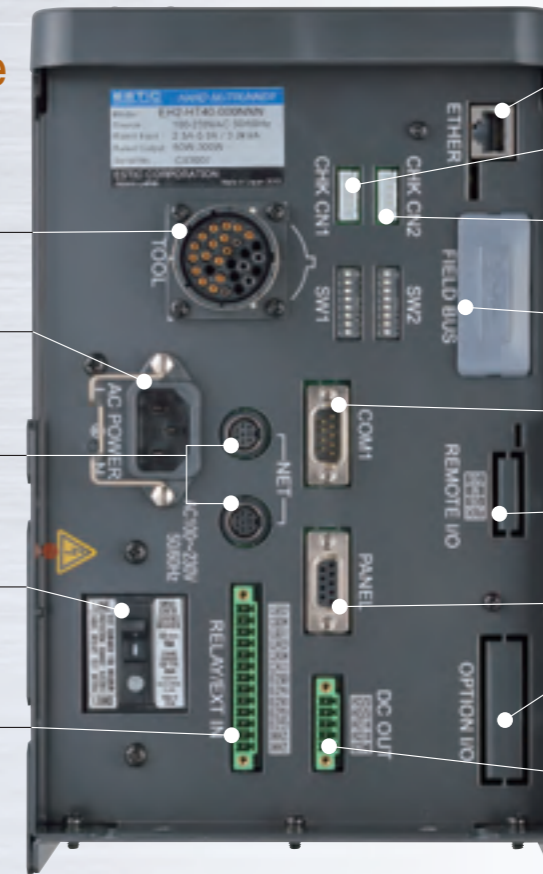

**ETHERNET**  
RJ45 connector to connect with ETHERNET.

**CHK CN1**  
Connector for monitor output.

**CHK CN2**  
Connector for monitor output.

**FIEDLBUS (Option)**  
EtherNet/IP, DeviceNet, Profinet, Profibus and CC-Link are available as an option.

**RS-232C (COM1)**  
ESTIC Management Software, Barcode scanner, ASCII data out

**REMOTE I/O (Option)**  
Remote I/O (Input 16/Output 16)  
\*Omron Remote I/O modules are required.

**PANEL**  
RS-422 to communicate with HMI.

**I/O (Option)**  
I/O (Input 16/Output 16)

**DC OUT**  
24VDC 1A

## Basic specifications for the controller

- **Fastening methods** : Torque control, Torque control Angle monitoring, Angle control, Torque or Angle control, Torque and Angle control, Yield control, Yield Angle control, Inspection torque control, Reverse Angle control
- **Fastening mode** : Selectable between Direct mode (Continuous fastening) and Pulse mode (Electrical pulse fastening).  
\* Some models have Pulse mode only or Direct mode only. Please see the details on page 25, 26 and 27.
- **No. of the fastening channel setting** : Max. 99 channels
- **Fastening result record** : Max. 33,000 records (Numbers of the records which can be stored in the controller varies depending on the items selected for fastening history)
- **Torque curve history** : Max. 30 records (OK Fastening: 20 records, NG Fastening: 10 records)
- **Ethernet** : Various protocols such as ESTIC protocol (ESTIC Management Software, ESTIC Data Logger), Open Protocol, and others are available.
- **FieldBus** : DeviceNet, EtherNet/IP, Profinet, Profibus, CC-Link are available as an option.
- **Remote I/O & PIO** : As the option. According to user requirement, Adding these options for necessary environment.
- **Memory** : Program/system parameter, Allocation of I/O, fastening Results, Fastening Result History, System Error History(FLASH-ROM Back-up) Torque Curve History(Battery Back-up) Parameter in USB memory.
- **Batch counter function** : nx OK and nx NG output
- **External dimensions** : W 60mm H 316mm D 262mm
- **Weight** : 7.7kg

## Versatile functions are included to further enhance fastening efficiency

### Multi channels

Tightening, loosening and retightening are necessary to detect the fitting or cross-thread condition in the bolt fastening operation. You can avoid the troublesome channel change operation and simply carry out the fastening in continuity by continuously defining the necessary fastening channels as one multi channel system.

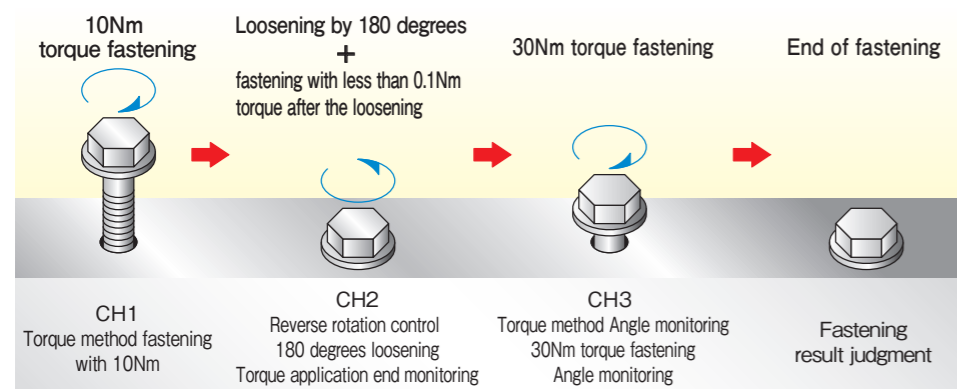

#### Multi channel No. designation

MC 1	
STAGE	CH(channels)
1	1
2	2
3	3

Fastening result OK

The maximum 99 channels including the multi channels and normal channels can be set. The set multi channels can perform as one CH in the job control function.

### Job control function

A convenient function to permit the integrated control in the various torque fastening operation. The max. 99 jobs can be controlled with the function. All of the channels and fastening operations can be programmed with a maximum of 30 steps per job.

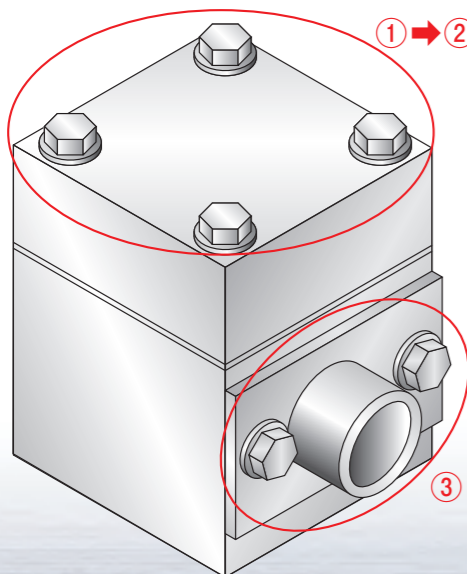

For instance, when 4 locations must be temporarily installed and then fully fastened with gaskets installed at the 4 locations, and then parts to be installed at two locations

#### Operation flow

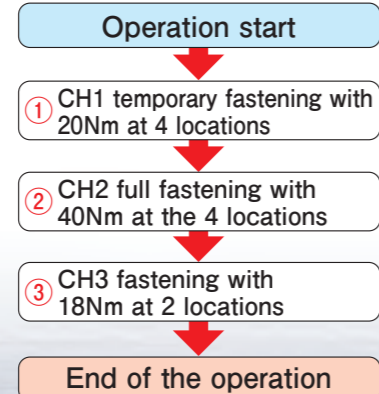

A series of steps is programmed as a JOB parameter in the job control function so that you may execute a job by designating the job number and the job end may be informed with the JOB OK output message.

#### Job control function

##### Designation of Job numbers

Job 1		
Steps	CH(channels)	No. of operations
1	CH1	4
2	CH2	4
3	CH3	2

Job OK

### High speed seating function

When fastening a screw at high rotation speed with a low target torque, the servo motor cannot stop promptly. This creates excess torque (overshoot), causing the fastening torque to be uneven and the workpiece to be damaged. As a solution to this, Handy2000 Lite employs overshoot reduction software to make your fastening faster and more secure.



Screen showing the management program

### Simplified PLC functions

The controller is equipped with a simplified sequence control function with AND, OR, and timer control. Logic programs can be set to select the ON lamps or set off a buzzer for a certain length of time depending on the fastening result of OK or NG.

### Free allocation function

The fastening result data stored in the controller and outputted on the external unit after every fastening can be freely selected. The function to select only necessary items can make the data size smaller. The control signals for the system control connectors (PIO), remote I/O, relay output, and no voltage contact input can also be freely allocated.

### Multi-spindles function

A maximum of 10 spindles can be operated for synchronous fastening without the help of external controls. The synchronous fastening allows for shorter operating times.

### Compatible with bar code readers

A bar code reader can be directly connected with the controller. The loaded data can be reflected in the fastening result. The fastening channel and job can be changed based on the loaded data when the identifier function is in use.

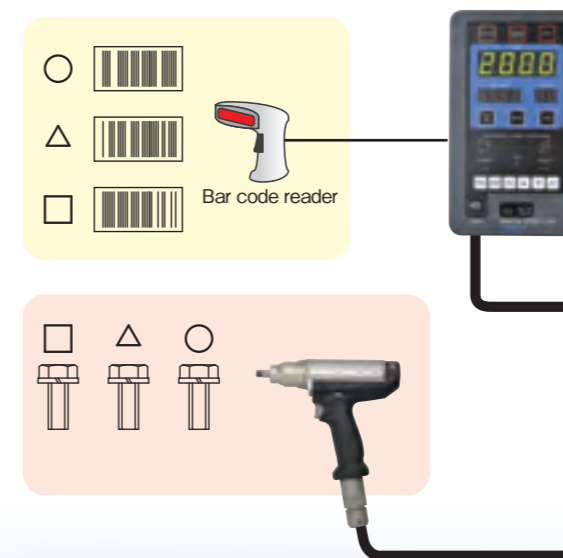

- By reading bar codes
- Storage/transmission of vehicle number + fastening data
  - Change of the model and operation to be carried out

# CONTROLLER(SYSTEM CONFIGURATION)

## Controller (system block diagram)

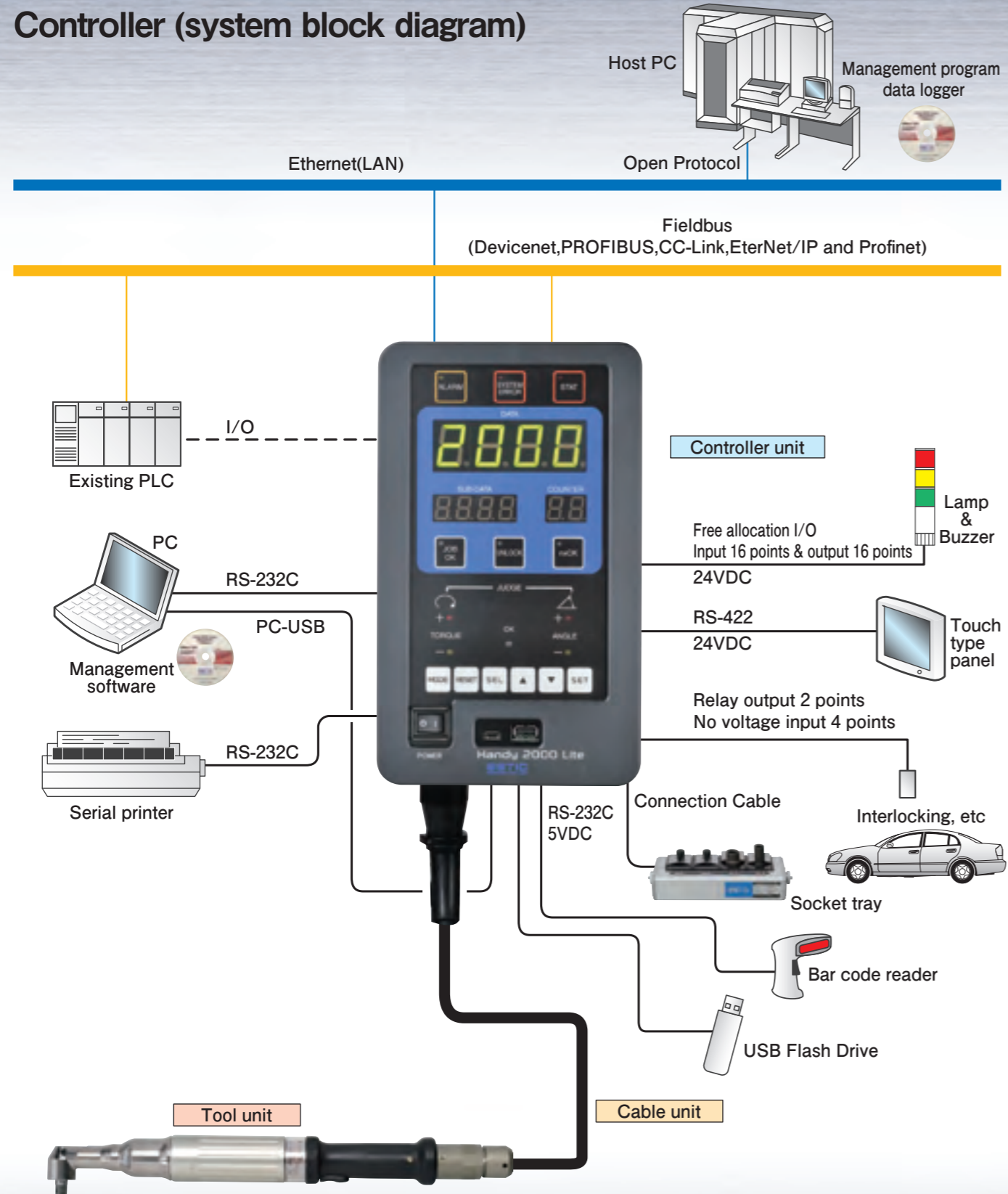

## Multi-spindles connection

Channels can be freely selected depending on the vehicle identification number. The fastening condition is set on the master controller and sent to the local controllers via NET cables for each fastening.

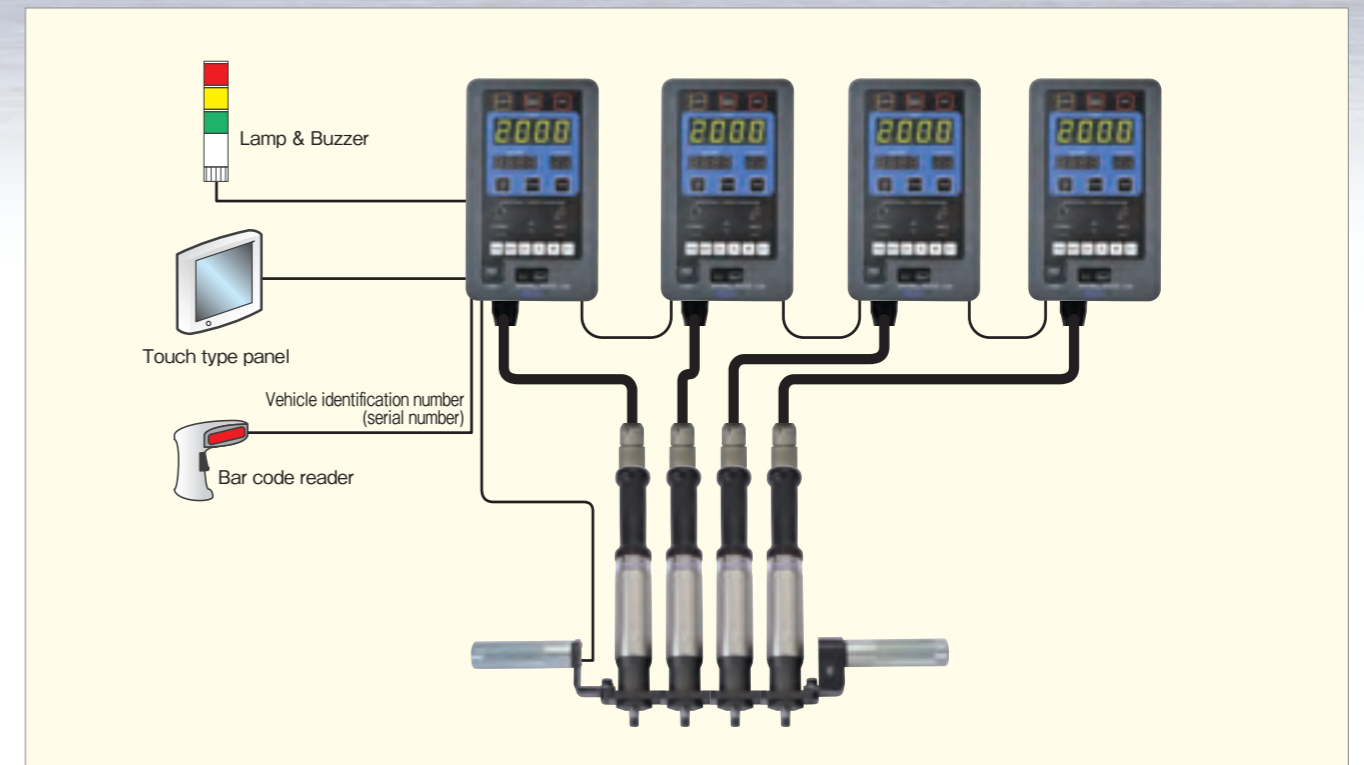

## Expanding network connection

The fastening results for up to 50 units\* can be compiled via the hub unit on ETHERNET. This wire saving connection can be used for the channel setting and interlocking from the outside with the use of Fieldbus. \* Variable depending on the network structure.

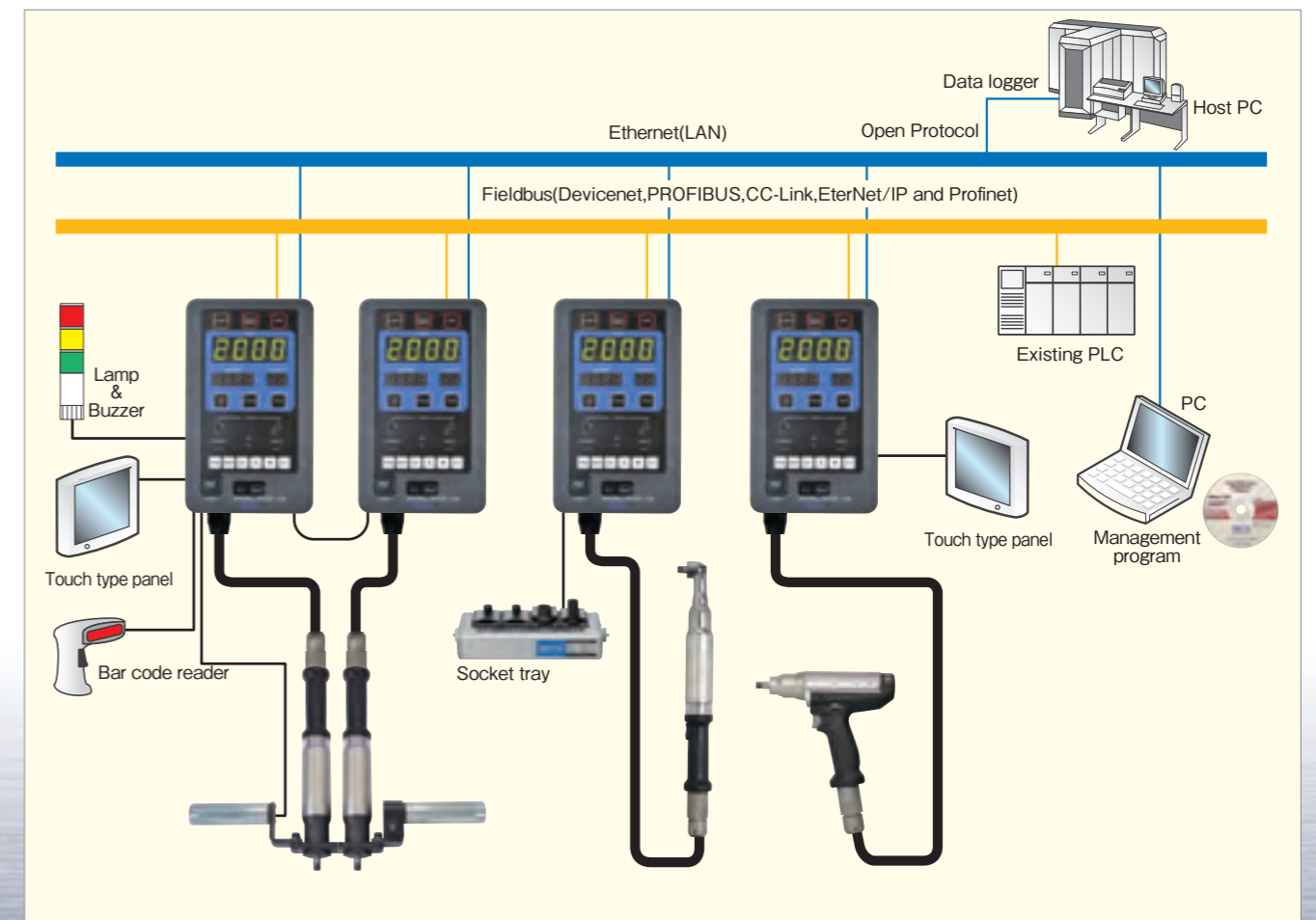

# A COST REDUCTION EXAMPLE WITH THE NEW FUNCTIONS

Peripheral units required in the past are not necessary  
Low cost and space saving system can be configured

## Lamp & Buzzer control

### Conventional model

The lamp and buzzer are controlled with OK and NG signals sent from the controller via programmed relay.

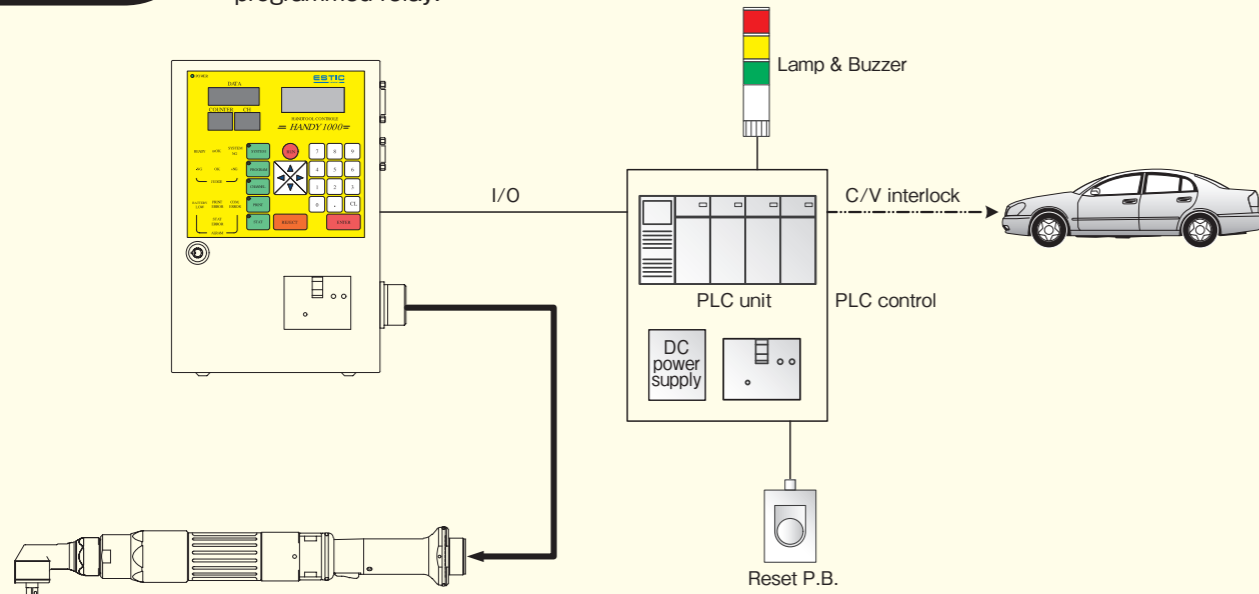

### Handy 2000 Lite

The lamp and buzzer can be directly controlled with the simplified PLC and I/O free allocation functions. Additional power supply for the peripheral units is not required as 24VDC power supply is provided.

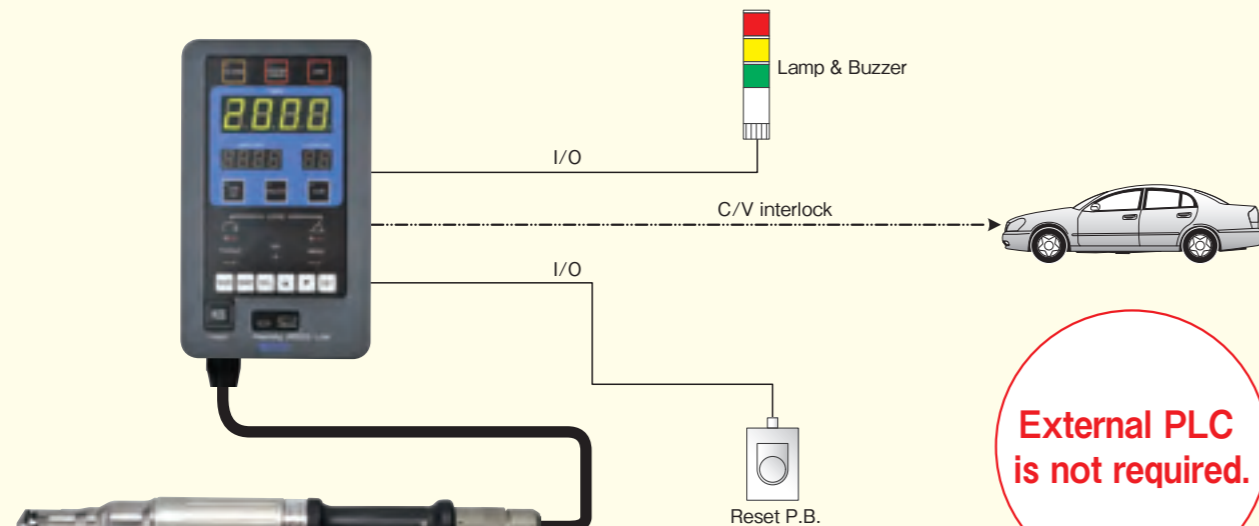

External PLC is not required.

## Data control + Interlock control

### Conventional model

The channels are controlled with the external PC.

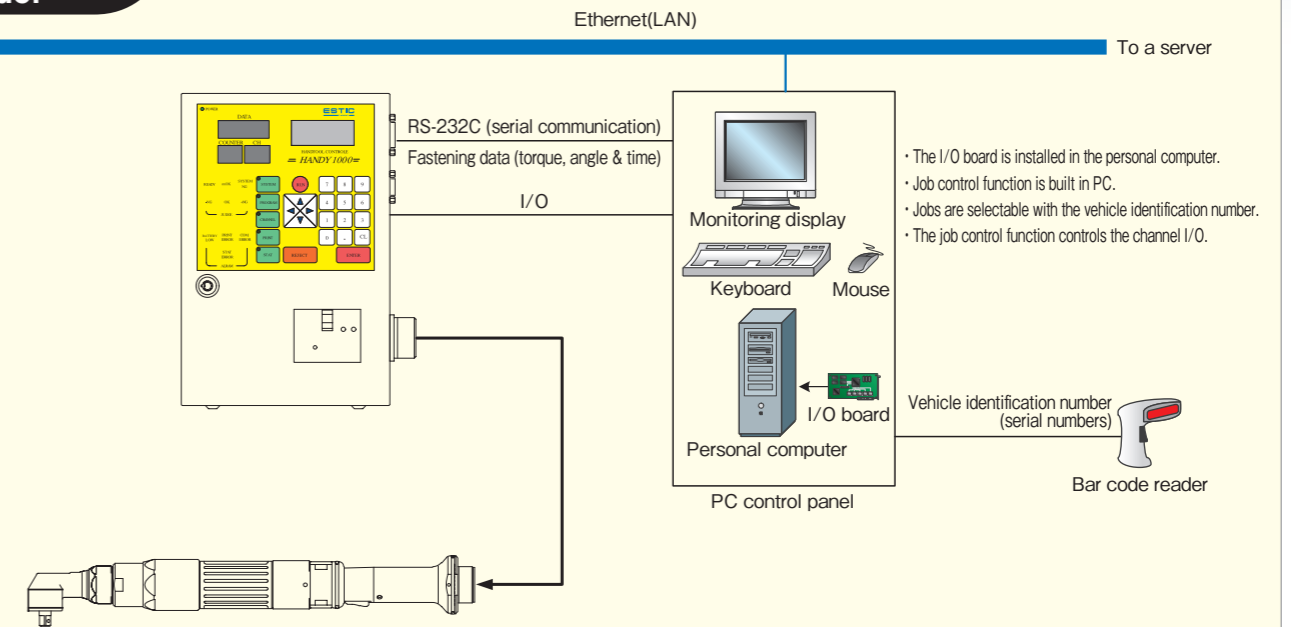

### Handy 2000 Lite

The fastening is controlled in the channels appropriate for the car model and parts with the job control function and job selecting function based on the vehicle identification number. 5VDC power supply for bar code readers is built in.

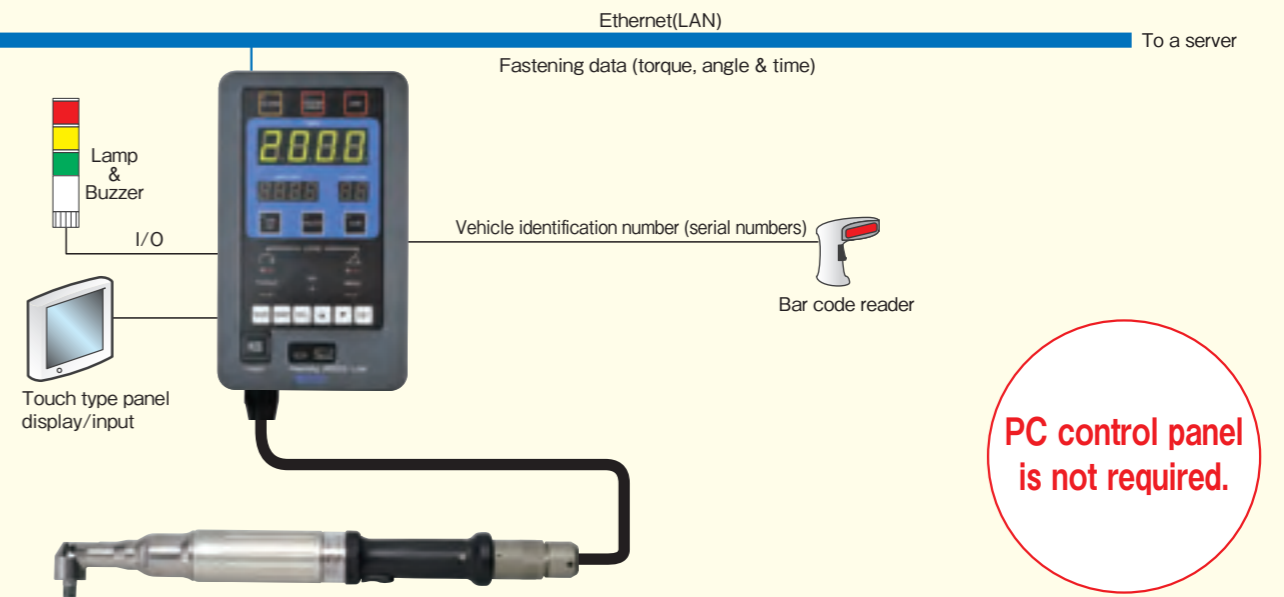

PC control panel is not required.

# HANDY 2000 MANAGEMENT SOFTWARE

Handy 2000 Management Software is a dedicated program used to take full advantage of all the Handy 2000 functions

## Functions to be set

Parameters can be loaded from the controller, written into the controller, stored and printed. The copy function is provided to help with quick start-ups.

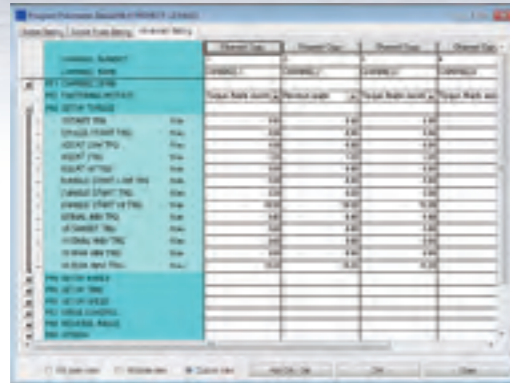

Program parameters

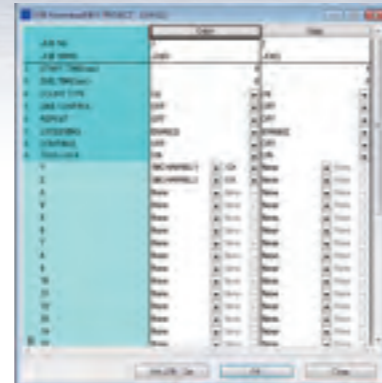

Fastening job setting

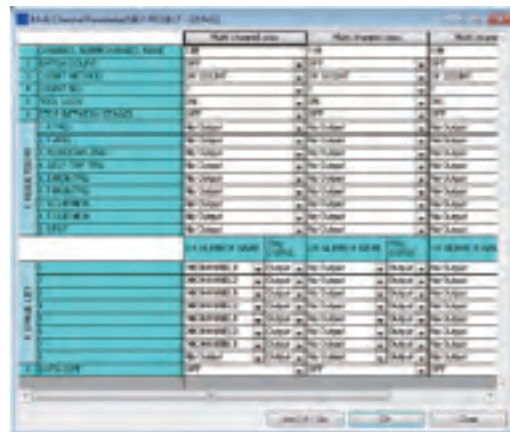

Multi channel parameter

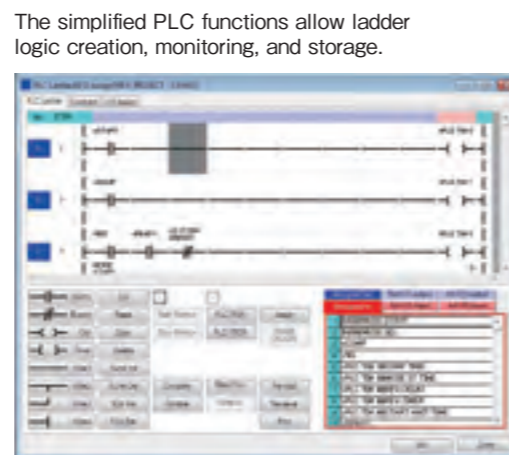

PLC ladder & I/O allocation

## History function

Fastening results, torque curves and system error data recorded in the controller can be loaded, displayed and printed with the function. Data is stored in CSV file format and can easily be imported into spreadsheets.

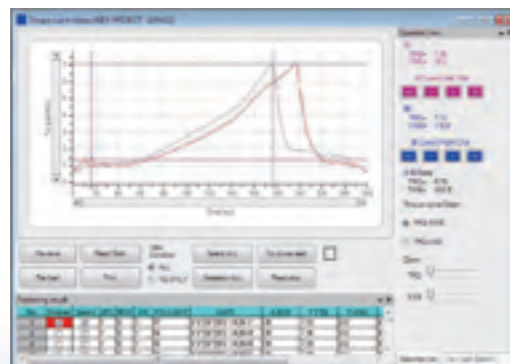

Torque curve data

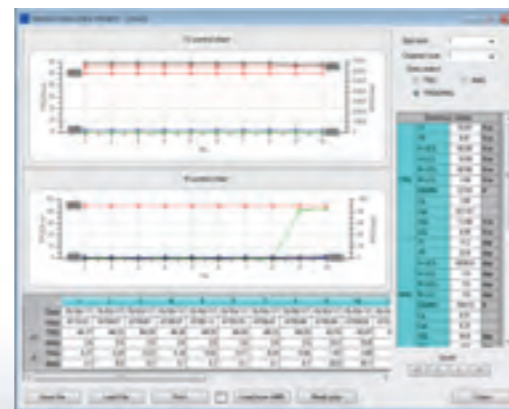

Statistics function

## Monitoring function

The latest fastening results and torque curve data stored in the controller can be displayed and printed. The data can be automatically or manually stored in CSV file format.

Fastening results displayed on the monitor screen.

## Allocation function

Allocation of virtual I/O items in PIO (IN), PIO (OUT), RELAY/EXTIN, remote I/O units, allocation of items added to the fastening result, and allocation of data including the related data in Fieldbus I/O unit are possible.



Allocation of fastening result items



Fieldbus I/O allocation

## Three types of interface connections are available (RS-232C, USB and ETHERNET)

RS-232C and USB are available for quick and easy connection for a single system. Ethernet is available to connect to a single and multiple systems.

## Verifying function

The verify function is available to compare a saved program file with the program file currently running in the system. This allows for added file control and change tracking.

## Maintenance functions

The maintenance function allows I/O monitoring, output signal forcing, torque and angle monitoring as well as displaying various tool data.

## Access limitation function

To prevent the unauthorized use with the access control using password.

- (Compatible OS) Windows10 32bit/64bit  
 Windows8/8.1 32bit/64bit  
 Windows7, SP1 32bit/64bit  
 WindowsVista, SP1.2 32bit  
 WindowsXP, SP3 32bit



EH2-R3450-A, EH2-R3600-A



EH2-R3270-A, EH2-R3370-A



EH2-R2180-A



EH2-R2050-A



EH2-R1020-A

ANGLE TOOL

Model	Tightening mode		Torque range		Max. speed (rpm)	Output shaft		Weight		Length (mm)
	Direct	Electric Pulse	(N m)	(ft lbs)		(mm)	(inch)	(kg)	(lb)	
EH2-R1020-A	○	○	4~20	3~14.8	1027	9.5 sq	3/8	1.4	3.1	386
EH2-R1030-A	○	○	6~30	4.4~22.1	702	9.5 sq	3/8	1.5	3.3	393
EH2-H1070-A		○*2	14~70	10.3~51.6	1500*3	12.7 sq	1/2	2.0	4.4	426
EH2-R2050-A	○	○	10~50	7.4~36.9	779	9.5 sq	3/8	2.1	4.6	434
EH2-R2080-A	○	○	16~80	11.8~59	480	12.7 sq	1/2	2.5	5.5	466
EH2-H2100-A		○*2	20~100	14.8~73.8	1125*3	12.7 sq	1/2	2.5	5.5	500
EH2-R2120-A	○	○	24~120	17.7~88.6	269	12.7 sq	1/2	3.0	6.6	514
EH2-H2140-A		○*2	28~140	20.7~103.3	753*3	19.0 sq	3/4	3.0	6.6	524
EH2-R2180-A	○	○	36~180	26.6~132.8	184	19.0 sq	3/4	3.2	7.1	538
EH2-R3270-A	○*1		54~270	39.9~199.3	265*4	19.0 sq	3/4	7.7	17	625
EH2-R3370-A	○*1		74~370	54.6~273	207*4	19.0 sq	3/4	7.7	17	625
EH2-R3450-A	○*1		90~450	66.4~332.1	172*4	25.4 sq	1	10.5	23.1	659
EH2-R3600-A	○*1		120~600	88.6~442.8	126*4	25.4 sq	1	10.5	23.1	659

\*1 Direct driven only (No Electric Pulse driven available). Please make sure to use together with a reaction bar/arm.  
 \*2 Electric Pulse driven only (No Direct driven available)  
 \*3 The speed when input voltage is 200V and the parameter SP.HIGH SPD is used.  
 Max. speed at input voltage 100V (EH2-H1070-A: 1000rpm, EH2-H2100-A: 750rpm, EH2-H2140-A: 500rpm)  
 \*4 Max. speed at input voltage 100V is a half speed of 200V

How to read the model numbers

EH2 - R1 020 - A (PP)

Handy 2000 series

Tightening mode

- R: Direct and Electric Pulse
- P: Electric Pulse
- H/S: High Speed Electric Pulse

Tool type

- A: Angle type
- S: Straight type
- SL: Straight type, lever start type
- SP: Straight type, push-to-start type
- SC: Straight type, connector start type
- P: Pistol type
- PH: Pistol type with involute spline

Output shaft

- Blank: Through Hole
- (PP): Pin Plunger
- (BP): Ball Plunger
- \*Ball/Pin Plunger is available on 9.5mm(3/8") and 12.7mm(1/2") and Angle/Pistol tool.

Max. rated torque

Torque in Nm (3 digits)

Motor power

- 0: 50W
- 1: 100W
- 2: 200W-1
- 3: 200W-2



EH2-R2120-PH



EH2-R2085-PH



EH2-P1050-P

Pulse Mode only



EH2-R1016-P



EH2-R0005-P

PISTOL TOOL

Model	Tightening mode		Torque range		Max. speed (rpm)	Output shaft		Weight		Length (mm)
	Direct	Electric Pulse	(N m)	(ft lbs)		(mm)	(inch)	(kg)	(lb)	
EH2-R0005-P	○	○	1~5	0.7~3.7	1694	9.5 sq	3/8	1.1	2.4	202
EH2-R0010-P	○	○	2~10	1.5~7.4	942	9.5 sq	3/8	1.1	2.4	202
EH2-H0015-P		○*2	3~15	2.2~11.1	3075*3	9.5 sq	3/8	1.2	2.6	204
EH2-R1016-P	○	○	3.2~16	2.4~11.8	1247	9.5 sq	3/8	1.4	3.1	220
EH2-R1016-PH	○	○	3.2~16	2.4~11.8	1247	9.5 sq	3/8	1.4	3.1	220
EH2-R1020-P	○	○	4~20	3~14.8	1053	9.5 sq	3/8	1.4	3.1	220
EH2-R1020-PH	○	○	4~20	3~14.8	1053	9.5 sq	3/8	1.4	3.1	220
EH2-R1030-P		○*2	6~30	4.4~22.1	3075*3	9.5 sq	3/8	1.4	3.1	223
EH2-P1050-P		○*2	10~50	7.4~36.9	1052	12.7 sq	1/2	1.7	3.7	248
EH2-S1050-P		○*2	10~50	7.4~36.9	2121*3	12.7 sq	1/2	1.7	3.7	252
EH2-R2085-PH	○*1		17~85	12.5~62.7	403	12.7 sq	1/2	2.7	6	335
EH2-R2120-PH	○*1		24~120	17.7~88.6	292	12.7 sq	1/2	2.8	6.2	335

\*1 Direct driven only (No Electric Pulse driven available). Please make sure to use together with a reaction bar/arm.  
 \*2 Electric Pulse driven only (No Direct driven available)  
 \*3 The speed when input voltage is 200V and the parameter SP.HIGH SPD is used.  
 Max. speed at input voltage 100V (EH2-H0015-P: 2000rpm, EH2-H1030-P: 2000rpm, EH2-S1050-P: 1400rpm)



EH2-R3320-S, EH2-R3420-S



EH2-R3200-S, EH2-R3260-S



EH2-R2035-S



EH2-R1016-S



EH2-R0005-SL



EH2-R0005-SC

STRAIGHT TOOL

Model	Tightening mode		Torque range		Max. speed (rpm)	Output shaft		Weight		Length (mm)
	Direct	Electric Pulse	(N m)	(ft lbs)		(mm)	(inch)	(kg)	(lb)	
EH2-R0005-SC	○	○	1~5	0.7~3.7	1694	9.5 sq	3/8	1.1	2.4	228
EH2-R0005-SL	○	○	1~5	0.7~3.7	1694	6.35 Hex	1/4	1.2	2.6	296
EH2-R0005-SP	○	○	1~5	0.7~3.7	1694	6.35 Hex	1/4	1.2	2.6	296
EH2-R0010-SC	○	○	2~10	1.5~7.4	942	9.5 sq	3/8	1.1	2.4	228
EH2-R0010-SL	○	○	2~10	1.5~7.4	942	6.35 Hex	1/4	1.2	2.6	296
EH2-R0010-SP	○	○	2~10	1.5~7.4	942	6.35 Hex	1/4	1.2	2.6	296
EH2-R1016-S	○	○	3.2~16	2.4~11.8	1247	9.5 sq	3/8	1.3	2.9	344
EH2-R1020-S	○	○	4~20	3~14.8	1053	9.5 sq	3/8	1.3	2.9	344
EH2-R2035-S	○	○	7~35	5.2~25.8	1169	9.5 sq	3/8	2.0	4.4	406
EH2-R2055-S	○	○	11~55	8.1~40.6	720	12.7 sq	1/2	2.2	4.9	431
EH2-R2085-S	○	○	17~85	12.5~62.7	403	12.7 sq	1/2	2.4	5.3	448
EH2-R2120-S	○	○	24~120	17.7~88.6	292	12.7 sq	1/2	2.5	5.5	448
EH2-R3200-S	○*1	○	40~200	29.5~147.6	397*2	19.0 sq	3/4	6.0	13.2	547.5
EH2-R3260-S	○*1	○	52~260	38.4~191.9	311*2	19.0 sq	3/4	6.0	13.2	547.5
EH2-R3320-S	○*1	○	64~320	47.2~236.2	258*2	19.0 sq	3/4	6.5	14.3	547.5
EH2-R3420-S	○*1	○	84~420	62~310	189*2	19.0 sq	3/4	6.5	14.3	547.5

\*1 Direct driven only (No Electric Pulse driven available). Please make sure to use together with a reaction bar/arm.

\*2 Max. speed at input voltage 100V is a half speed of 200V

Controller models and options

Model	Fieldbus option					I/O option		Power source (V)
	DeviceNet	Profibus	CC-Link	Ethernet/IP	Profinet	Remote IO	Extend IO	
EH2-HT40-000NNN								Single Phase 100 - 230VAC
EH2-HT40-000RNN						●		
EH2-HT40-000NPN							●	
EH2-HT40-000RNP						●	●	
EH2-HT40-000NDN	●							
EH2-HT40-000RDN	●					●		
EH2-HT40-000NDP	●						●	
EH2-HT40-000RDP	●					●	●	
EH2-HT40-000NPN		●						
EH2-HT40-000RPN		●				●		
EH2-HT40-000NPP		●					●	
EH2-HT40-000RPP		●				●	●	
EH2-HT40-000NCN			●					
EH2-HT40-000RCN			●			●		
EH2-HT40-000NCP			●				●	
EH2-HT40-000RCP			●			●	●	
EH2-HT40-000NEN				●				
EH2-HT40-000REN				●		●		
EH2-HT40-000NEP				●			●	
EH2-HT40-000REP				●		●	●	
EH2-HT40-000NTN					●			
EH2-HT40-000RTN					●	●		
EH2-HT40-000NTP					●		●	
EH2-HT40-000RTP					●	●	●	



How to read the model numbers

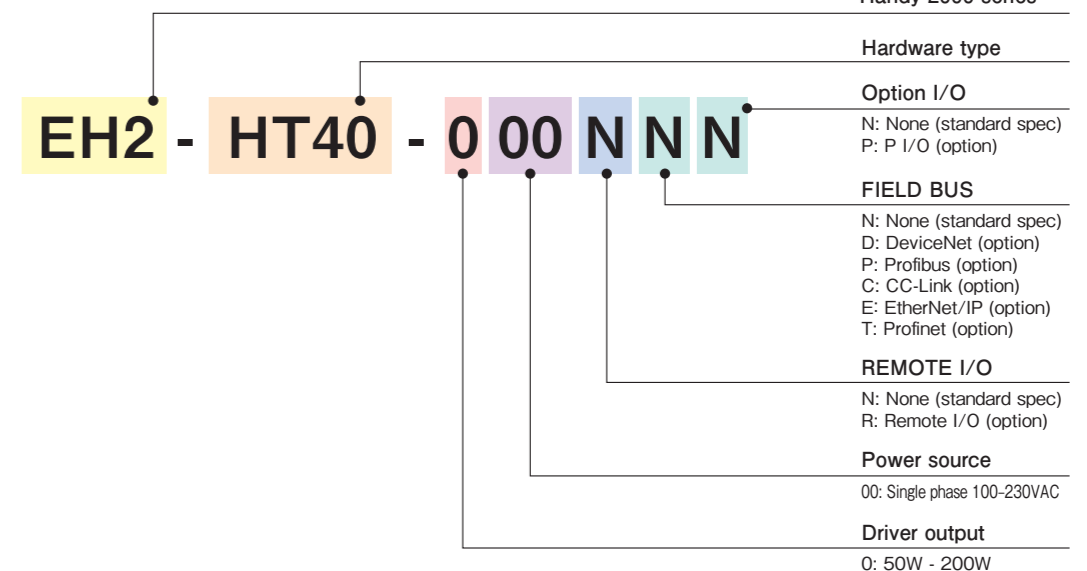

ELECTRIC HANDHELD NUTRUNNER CONTROLLERS

# TRACER ARM

One of the new applications of Handy 2000 Lite is the "TRACER ARM".  
An Assisting Arm with Position Detection Function for Handy 2000 Lite!

- Eliminating operator errors!
- Eliminating reaction force!
- Improving operating efficiency!
- Simple Configuration!

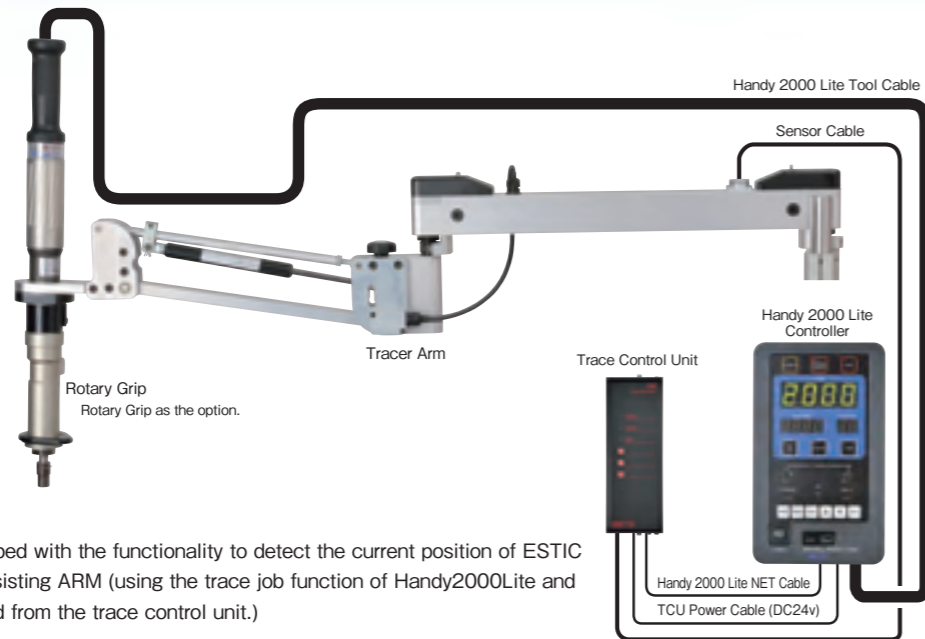

"TRACER ARM" is equipped with the functionality to detect the current position of ESTIC handheld tools on the assisting ARM (using the trace job function of Handy2000Lite and the position data obtained from the trace control unit.)

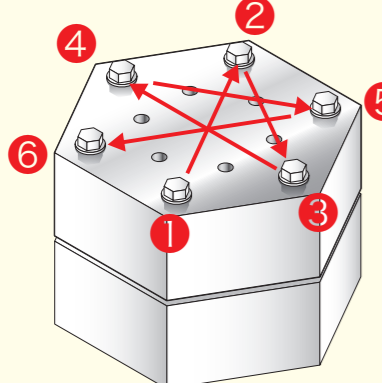

**Step 1** CH1 Pretightening with 21N-m at 6 locations  
\*Fastening sequence: Start 1->2->3->4->5->6 End

**Step 2** CH2 Loosening with 90 degrees at 6 locations  
\*Fastening sequence: Start 1->2->3->4->5->6 End

**Step 3** CH3 Final tightening with 49N-m at 6 locations  
\*Fastening sequence: Start 1->2->3->4->5->6 End

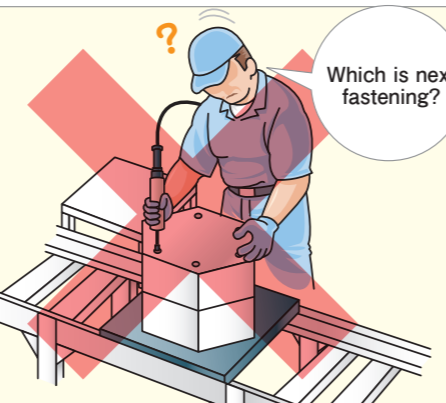

Currently, operator errors such as incomplete fastening, wrong position fastening, and wrong fastening sequence. Additionally, sometimes fastening maneuverability is not easy for the operator.

Adopting this "TRACER ARM" with functionality of detecting the current position of ESTIC handheld tool on the assisting ARM interlocking fastening each positions, The operator can eliminate current errors and also perform fastening with easy handling.

## Work Flow Example

- 1 Read the bar code on the application, and fastening program is automatically selected.
- 2 Model information selected by the Bar code reader is sent to the Touch screen, and fastening position is displayed in a pink circle.  
\*The application image is pre registered in the Touch screen
- 3 Touch screen guides the Operator to the position to be fastened next. By following the Touch screen, Operator can complete sequenced fastening.
- 4 Fastening Data (Fastening results) can be stored in the Controller.
- 5 Fastening Data (Fastening results) can be sent to the plant's server as well.

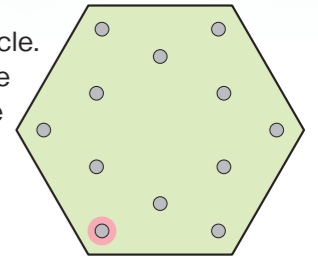
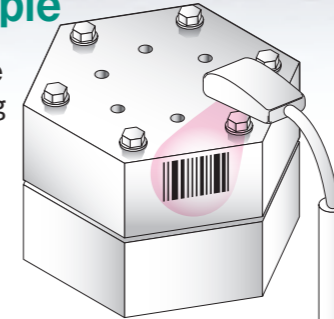

## [TRACER ARM SYSTEM CONFIGURATION ITEMS LIST]

Arm Model	EH2-TA0505-*AT1	EH2-TA0505-*AT1G	EH2-TA0505-*AT2	EH2-TA0505-*AT2G	EH2-TH0505-*AT3	EH2-TH0505-*AT3G	EH2-TH0505-*AT4	EH2-TH0505-*AT4G
		with Rotating grip		with Rotating grip		with Rotating grip		with Rotating grip
1 Applicable Tool Model	EH2-R0005-SL/SP EH2-R0010-SL/SP	EH2-R0005-SC EH2-R0010-SC	EH2-R1016-S EH2-R1020-S		EH2-R2035-S		EH2-R2055-S EH2-R2085-S EH2-R2120-S	
2 Tool Cable	EH2-CVS**SS (please see page 31)							
3 Rotating Grip	-	EH2-RG01 (attachments for EH2-TA0505-*AT1G)	-	EH2-RG02 (attachments for EH2-TA0505-*AT2G)	-	EH2-RG03 (attachments for EH2-TA0505-*AT3G)	-	EH2-RG04 (attachments for EH2-TA0505-*AT4G)
4 Cable for Rotating Grip (Rotating grip side)	-	EH2-CVG1-001 (attachments for EH2-TA0505-*AT1G)	-	EH2-CVG2-050 (attachments for EH2-TA0505-*AT2G)	-	EH2-CVG2-050 (attachments for EH2-TA0505-*AT3G)	-	EH2-CVG2-050 (attachments for EH2-TA0505-*AT4G)
5 Cable for Rotating Grip (Controller side)	-	-	-	EH2-CVG3-003 (attachments for EH2-TA0505-*AT2G)	-	EH2-CVG3-003 (attachments for EH2-TA0505-*AT3G)	-	EH2-CVG3-003 (attachments for EH2-TA0505-*AT4G)
6 ELAY/EXT IN Connector (wired with EH2-CVG3-003)	-	-	-	EH2-FCN13-RL (attachments for EH2-TA0505-*AT2G)	-	EH2-FCN13-RL (attachments for EH2-TA0505-*AT3G)	-	EH2-FCN13-RL (attachments for EH2-TA0505-*AT4G)
7 Resolver Cable	EH2-CVR3-010 (1m), EH2-CVR3-050 (5m)							
8 NET Cable	EH2-CVNK-*** (please see page 33)							
9 Trace Control Unit	EH2-TCU-N (standard type), EH2-TCU-E (with extended I/O)							
10 TCU Power cable	EH2-CVDC-030 (attachments for Trace Control Unit)							
11 Termination Resistor	EH2-CNST (required 2 pieces)							
12 TCU Bracket	EH2-TCU-BRKT2							
13 Arm Mount Bracket	EH2-SAFM500 (for floor mounting) EH2-SAWM200 (for wall mounting)				EH2-HAFM500 (for floor mounting)			

Note : \*mark in the arm model EH2-TA0505-\* and EH2-TH0505-\* is replaced with the symbol of operation type of the arm to complete the model number.  
R : Right arm type L : Left arm type



## Highly durable molded connector with unique double shell construction

The cable is extremely durable and easy to handle with a high strength elastic aramid fiber core covered by a molded resin. The connector has a dual shell constructed from machined duralumin to assure a secure cable connection while maintaining flexibility.

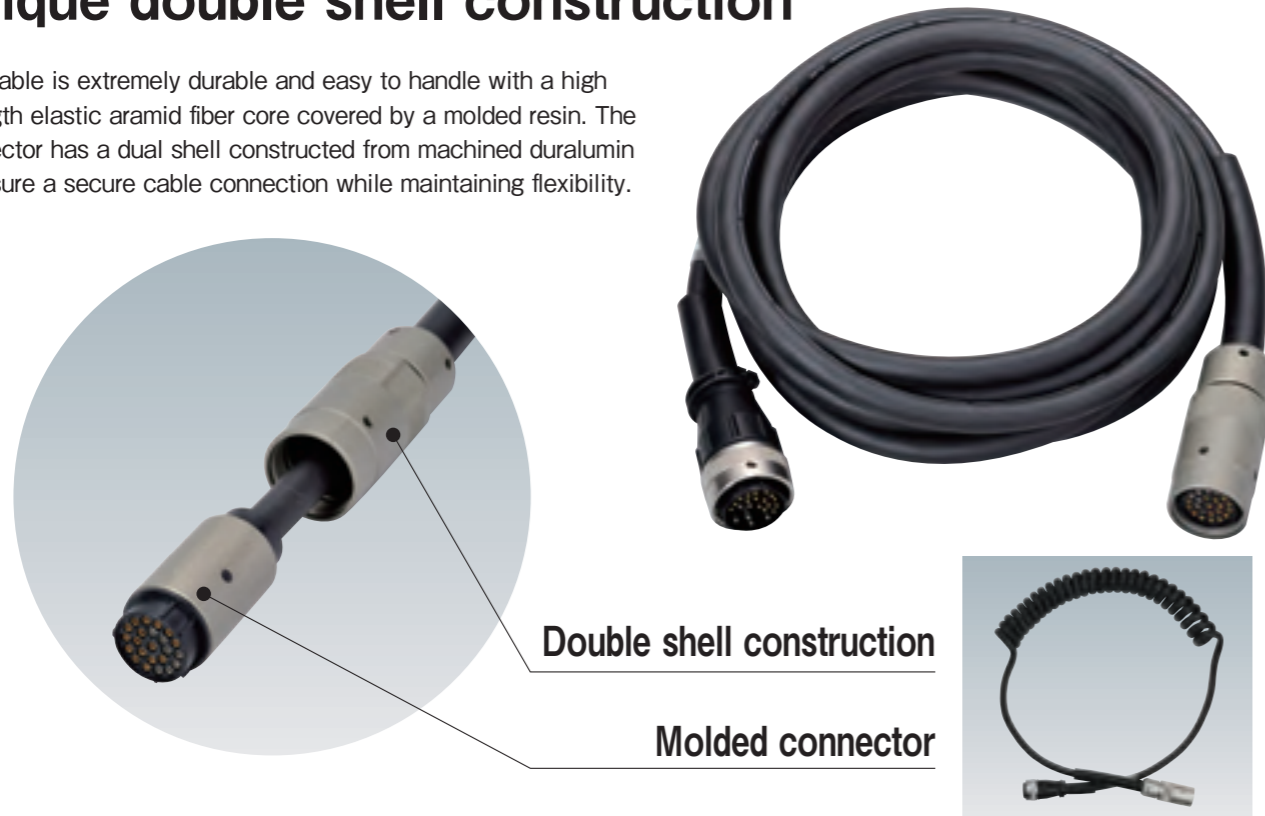

Double shell construction

Molded connector



Spiral Cable

### List of the models

Model	Length (m)	Outside diameter (mm)	Remarks
EH2-CVS05-SS	5	13.5	* Made to order
EH2-CVS10-SS	10		
EH2-CVS15-SS	15		
EH2-CVS20-SS	20		
EH2-CVS25-SS	25		
EH2-CVS30-SS	30		
EH2-CVC03-SS	1.5		
EH2-CVE05-SS	5	Extension Cable	
EH2-CVE10-SS	10		
EH2-CVE15-SS	15		

### Cable Adapter



EH2-CVAD-L

EH2-CVAD-U

Model	Product name	Remarks
EH2-CVAD-L	L Cable Adapter	Cable for bent 90 degrees
EH2-CVAD-U	U Cable Adapter	Cable for bent 180 degrees

### Tool Accessories

Hanging fixture for the straight and angle type models



EH2-SB01



EH2-SH01

Hanging fixture for the pistol type models



EH2-PH01



EH2-PH02

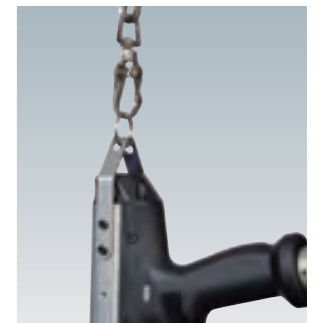

EH2-PH03

Model	Product name	Remarks
EH2-SB01	Hanging fixture	For straight and angle tools (100 W type): Horizontal
ENRH-SB02		For straight and angle tools (200 W type): Horizontal
EH2-SH01		For straight and angle tools: Vertical
EH2-PH01		For pistol tool: Horizontal/upside down
EH2-PH02		For pistol tool: Horizontal, For straight tool (50 W type) : Horizontal
EH2-PH03		For pistol tool: Vertical

Note: Please inquire for hanging fixture for tool type EH2-R3 series

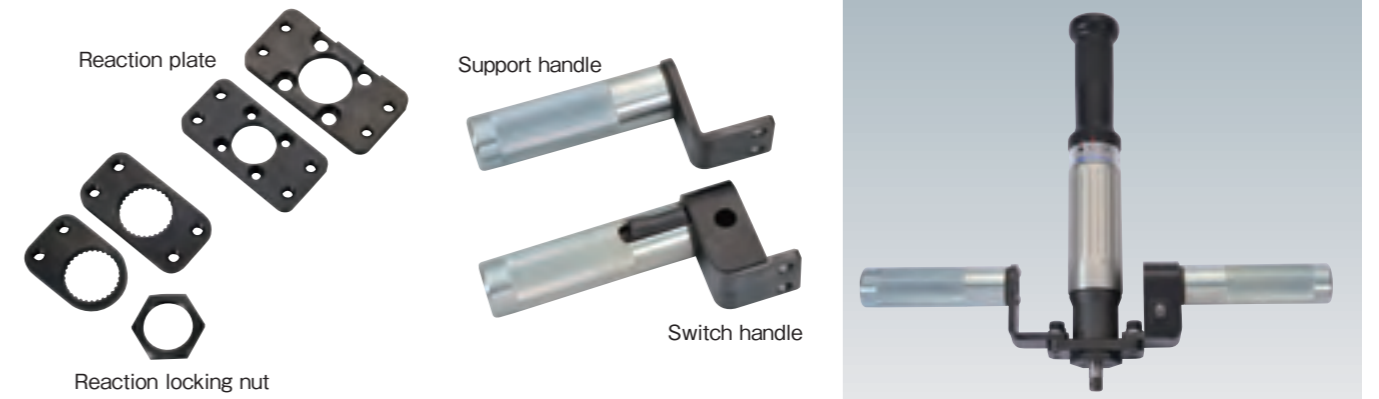

Reaction plate

Support handle

Reaction locking nut

Switch handle

An example of the handle installation

Model	Product name	Remarks
ENRH-RP20S	Reaction plate	For 16/20 Nm straight and pistol tools (single)
ENRH-RP20W		For 16/20 Nm straight and pistol tools
ENRH-RP35W		For 35Nm straight tool
ENRH-RP90W		For 55/85/120Nm straight and pistol tools
ENRH-LNM30	Reaction locking nut	For ENRH-PR20S/W

Model	Product name	Remarks
ENRH-SH01	Support handle	
ENRH-SH02	Switch handle	With direction selector switch
EH2-LS01	Short switching lever	For straight and angle tools (100/200W type)
EH2-LS02	Long switching lever	For straight and angle tools (100/200W type)

Note: Not applicable for tool type EH2-R3 series

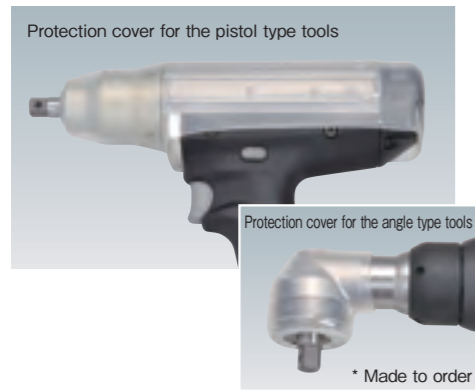

Model	Product name	Remarks
EH2-PP01	Protection cover	For pistol tool EH2-P1050-P
EH2-PP02		For pistol tool 16/20Nm
EH2-PP03		For pistol tool 5/10Nm
EH2-PP04		For pistol tool EH2-H0015-P
EH2-PP05		For pistol tool EH2-H1030-P
EH2-PP06		For pistol tool EH2-S1050-P

Controller Accessories



EH2-CP02-UL1    EH2-CP02-CN1    EH2-CP02-UK1    EH2-CP02-EU1    EH2-CP02-TH1

Model	Product name	Remarks
EH2-CP02-UL1	Power cord	For Japan and USA 100V 2m
EH2-CP02-CN1		For China 200V 2m
EH2-CP02-UK1		For UK 200V 2m
EH2-CP02-EU1		For Europe 200V 2m
EH2-CP02-TH1		For Thailand 200V 2m
EH2-CP02-CE2		No plug 200V 2m

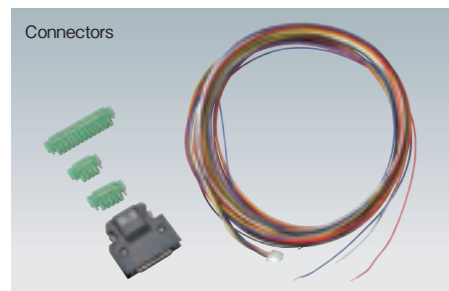

Model	Product name	Remarks
EH2-FCN13-RL	Connectors	For relay/exit-in connection
EH2-FCN04-RM		For the remote I/O connection
EH2-FCN05-DC		For DC OUT connection
ENRZ-CN36-EX		For PIO

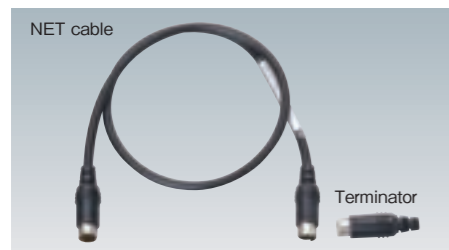

Model	Product name	Remarks
EH2-CVNK-005	NET cable	For Multi spindle and Trace control unit: 0.5m
EH2-CVNK-010		For Multi spindle and Trace control unit: 1m
EH2-CVNK-030		For Multi spindle and Trace control unit: 3m
EH2-CNST	Terminator	

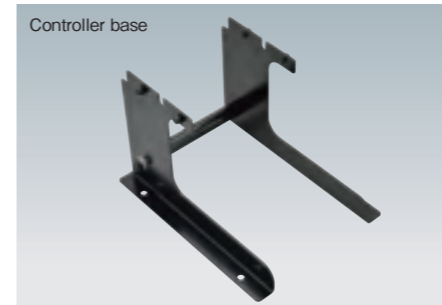

Model	Product name	Remarks
EH2-CF02	Controller base	For vertically setting the controller

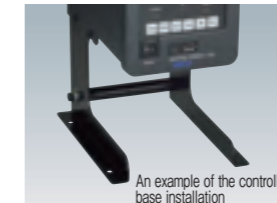

Socket Tray



Model	Product name	Remarks
EH2-ST4	Socket Tray	4 sockets type (4 holders)
EH2-ST8		8 sockets type (8 holders)
EH2-CVST-005	Connection cable	0.5m    An accessory of the socket tray
EH2-CVST2-010	Expansion cable	1m    Cable between Socket tray and Socket tray
EH2-CVST3-050	Extension cable	5m
EH2-CVST3-100		10m
EH2-CVST3-150		15m    Cable between Handy2000Lite controller and socket tray

- Socket Tray is a unit to assist selecting a right socket and a right tightening program in the process which requires to change multiple sockets.
- Easy settings by Management software (version 7.12 or later) on PC.
- Socket holder size is adjustable by an adjustable plate.
- 2 LEDs (Red, Green) indicate the status of each socket (Socket to pick, Socket is picked, Wrong socket is picked).
- Maximum of 24 sockets can be connected.

Software



Model	Product name	Remarks
EH2-PC	Handy 2000 Management software	Multi language (Japanese, English)
ENRZ-CVSR-015	Serial communication cable	1.5m
ENRZ-CVSR-050		5m
ENRZ-CVSR-100		10m

Data Logger: ESW-DL

- The software works for connecting with combination of different series of controllers.
- Data output by a controller is stored in a database and displayed on the screen.
- Torque (Press) graph can be displayed on the screen as well.
- Obtained tightening (pressing) data can be exported with excel format on schedule, and it makes easier for data analysis.
- OS: Windows10, Windows8/8.1, Windows7 SP1